

P NOZZLE CAP III

适用于P用尖中栓的直体瓶盖诞生了！



适用于P用尖中栓的直体瓶盖诞生了。

该产品不仅可以作为单品使用、直体的形状设计也便于与其他产品组合成系列产品使用。

适用于头发护理、头皮护理、生发剂等相关产品。



P NOZZLE CAP III — 搭配P用尖中栓使用的直体瓶盖 —

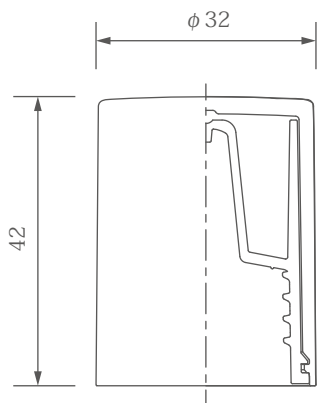

P NOZZLE CAP III

材质：PP
成型方法：注塑
颈部尺寸：24/410

可搭配使用的中栓

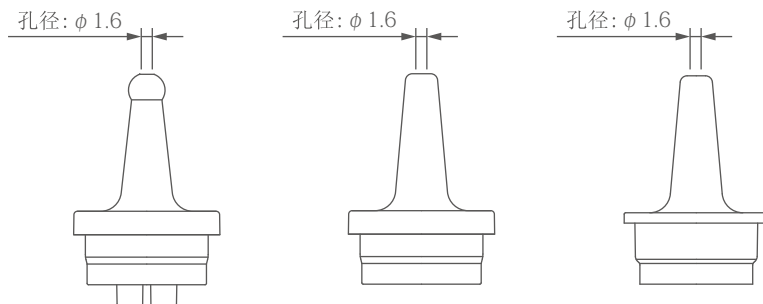

P用球头尖被栓

P用尖嘴被栓

P用尖中栓

搭配 PET / PET-G 材质瓶型使用

搭配 PE / PP 材质瓶型使用

可通过不同的加饰方法改变产品形象



丝印



烫金



烫金边



渐变喷涂

其他尖盖的简介

除本次介绍的瓶盖之外、我司还有其他尖盖产品。
可以根据产品需求选用。

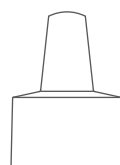

P用尖盖
〈搭配上述中栓使用〉

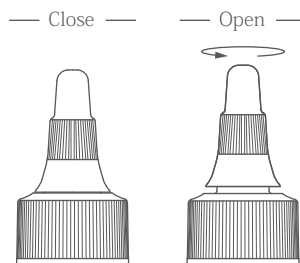

P尖嘴盖
〈扭动旋开式样〉

可搭配P NOZZLE CAP III使用的瓶型简介(部分产品)



CUBE-200A*

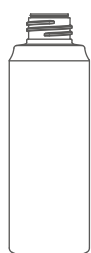

DOPI-120



OPT-150



PEMIS-150

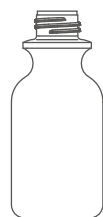

OZH-120S



JN-120



OPPS-150

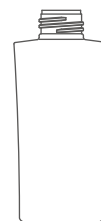

OMP-120

*日本制造

PET

PE

PP